

cerno®

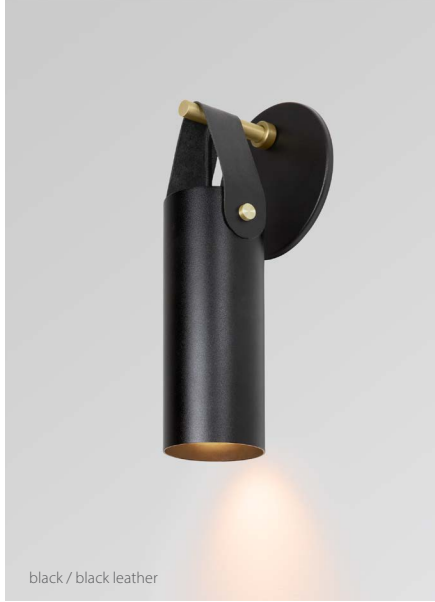

DESIGNED AND MADE IN CALIFORNIA

Spero Sconce



black / black leather



brass / brown leather



distressed brass / black leather



white / tan leather



white / tan leather detail



brass / brown leather detail

## Spero sconce

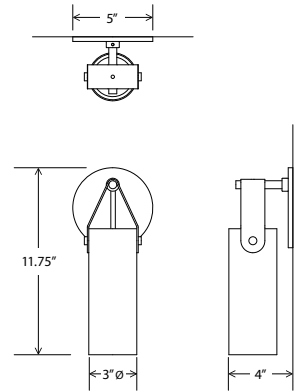

Dimensions: 5" x 11.75" x 4"  
 Product weight: 2lb  
 Light source: medium base E26 socket  
 Lamping: E26 base, PAR20 lamp, 20 W max  
 Input voltage: 250 V AC max  
 Specifications subject to change



Spero Sconce part # 03-260- -

### Standard Combinations

black / black leather  
 brass / brown leather  
 distressed brass / black leather  
 white / tan leather

B  
 R  
 D  
 W

### Bulb Options

PAR20 LED bulb included -  
 2700 K, 90CRI, 40 degree flood  
 no bulb included

27  
 00

**For expanded offering see  
 Specification Sheet.**

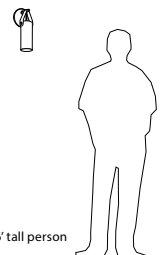

*The Spero sconce illustrates a minimalist mindset without sacrificing design details that define the fixture. Pronounced metal accents join the leather strap to the shade, adding a balanced contrast between the different elements. The bottom aperture allows the delivery of ample light while shielding the rest of the space from glare.*

**▲WARNING.** California Proposition 65 Warning for California Consumers. This product can expose you to chemicals including wood dust and lead which are known to the State of California to cause cancer or birth defects or other reproductive harm. For more information go to [www.P65Warnings.ca.gov](http://www.P65Warnings.ca.gov)

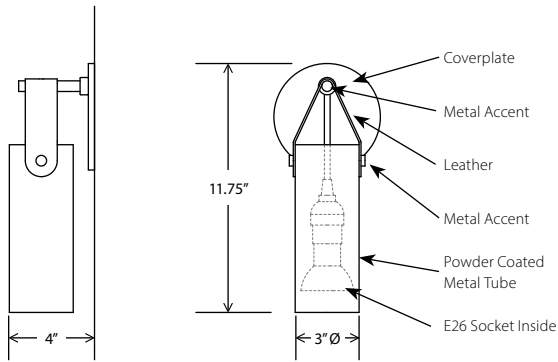

Standard combinations on the previous page are stocked. Fixture specified by using the SKU builder below are subject to increased lead times and minimum order quantities.

Spero Sponce part # 03-260-

*Shade Finish*

- textured black powder coat (CM-049)
- textured white powder coat (CM-060)
- brushed brass (CM-120)
- distressed brass (CM-117)

*Metal Accent Finish*

- textured black powder coat (CM-049)
- textured white powder coat (CM-060)
- brushed brass (CM-120)
- distressed brass (CM-117)

*Coverplate Finish*

- textured black powder coat (CM-049)
- textured white powder coat (CM-060)
- brushed brass (CM-120)
- distressed brass (CM-117)

*Leather Finish*

- brown leather (CM-098)
- black leather (CM-127)
- tan leather (CM-128)

*Bulb Options*

- PAR20 LED bulb included - 2700 K, 90CRI, 40 degree flood, 6.5 W, 650 lumens
- no bulb included

|    |    |   |   |
|----|----|---|---|
| B  | W  | R | D |
| B  | W  | R | D |
| B  | W  | R | D |
| R  | B  | T |   |
| 27 | 00 |   |   |

## PHOTOMETRIC POLAR GRAPH

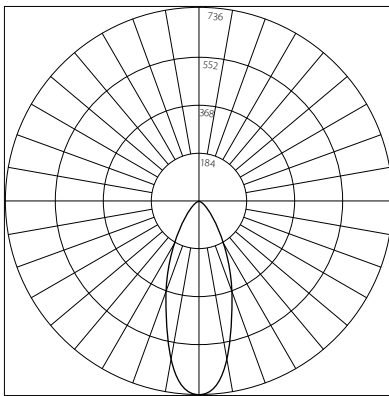

Maximum Candela = 736  
 Located at  
 Horizontal Angle = 0,  
 Vertical Angle = 0

Output for 40 degree flood PAR20 bulb.  
 Actual output will vary if a different bulb type is installed.

## TECHNICAL SPECIFICATIONS

Light source: medium base E26 socket  
 Lamping: 1x E26 base, PAR20 lamp, 20 W max  
 Input Voltage: 250 V AC max

Specifications subject to change



Included PAR20 LED bulb specifications (optional)  
 Light output: 520 Lumens (source)  
 Light color: 2700 K  
 Color accuracy: 90+ CRI  
 Power usage: 6.5 W  
 Dimmability: Triac or ELV

## FINISHES



textured black powder coat (CM-049)



brushed brass (CM-120)

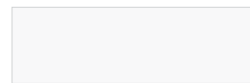

textured white powder coat (CM-060)



distressed brass (CM-117)



black leather (CM-127)



brown leather (CM-098)

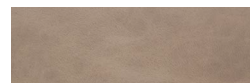

tan leather (CM-128)

**WARNING.** California Proposition 65 Warning for California Consumers. This product can expose you to chemicals including wood dust and lead which are known to the State of California to cause cancer or birth defects or other reproductive harm. For more information go to [www.P65Warnings.ca.gov](http://www.P65Warnings.ca.gov)